



# SERVICE

**Weitere Informationen**  
erhalten Sie von Ihrem autorisierten LGB-Händler und bei  
Ernst Paul Lehmann Patentwerk  
Saganer Strasse 1-5  
D-90475 Nürnberg  
DEUTSCHLAND  
Tel.: (0911) 83707 0  
Fax: (0911) 83707 70  
www.lgb.de

**Achtung!** Geben Sie bei der Bestellung eines Ersatzteils bitte die Nummer der Zeichnung oben auf dieser Seite (z. B. "2019S-1") und die Nummer des Teils auf der Zeichnung (z. B. "15") an.

**Achtung!** Produkte und technische Daten können sich ohne Vorankündigung ändern.

LGB, LGB of America, LEHMANN und der LGB TOYTRAIN-Schriftzug sind eingetragene Marken der Firma Ernst Paul Lehmann Patentwerk, Nürnberg, Deutschland. Andere Marken sind ebenfalls geschützt. © 2002 Ernst Paul Lehmann Patentwerk.

**For more information,**  
contact your authorized LGB retailer or:

<i>in North America</i>	<i>in all other areas</i>
LGB of America	Ernst Paul Lehmann Patentwerk
6444 Nancy Ridge Drive	Saganer Strasse 1-5
San Diego, CA 92121	D-90475 Nürnberg
Telephone: (858) 795-0700	Telephone: (0911) 83707 0
Fax: (858) 795-0780	Fax: (0911) 83707 70
USA	GERMANY
www.lgb.com	www.lgb.de

**Attention!** When ordering a part, please include the drawing number at the top of this page (e.g., "2019S-1") and the number of the part in the drawing (e.g., "15").

**Attention!** Products and specifications are subject to change without notice.

LGB, LGB of America, LEHMANN and the LGB TOYTRAIN logo-type are registered trademarks of Ernst Paul Lehmann Patentwerk, Germany. Other trademarks are the property of their owners. © 2002 Ernst Paul Lehmann Patentwerk.

25432

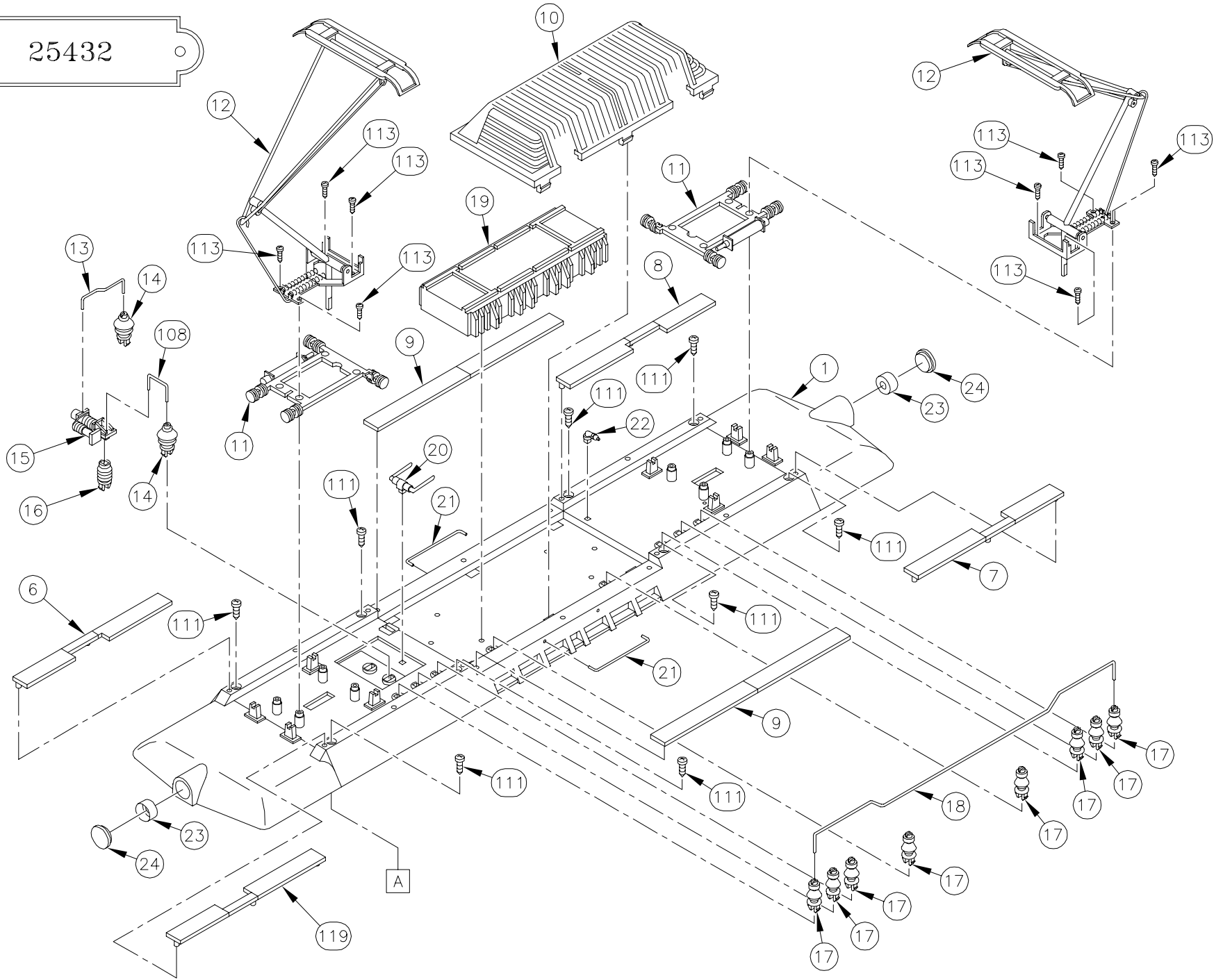

25432

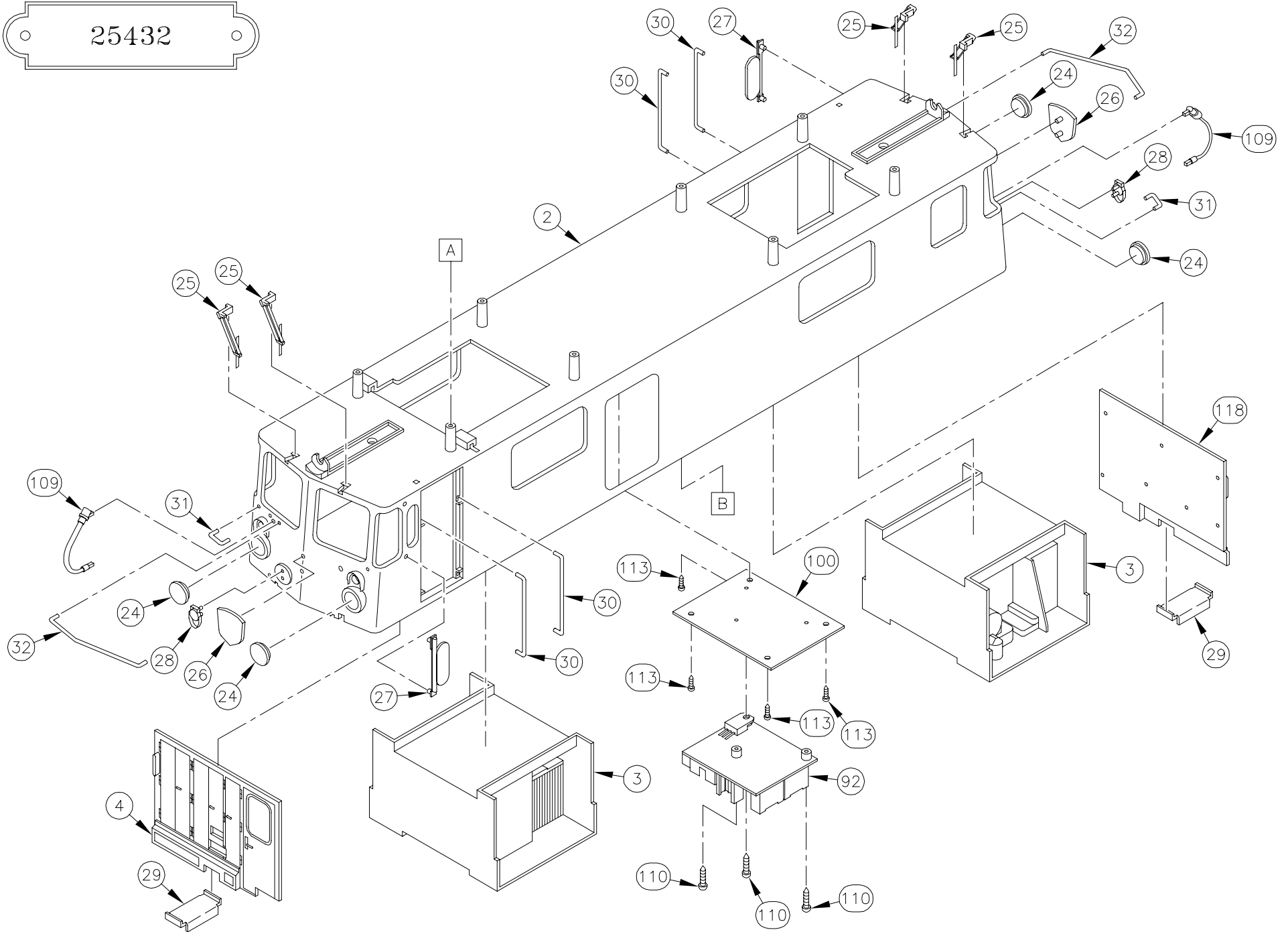

25432

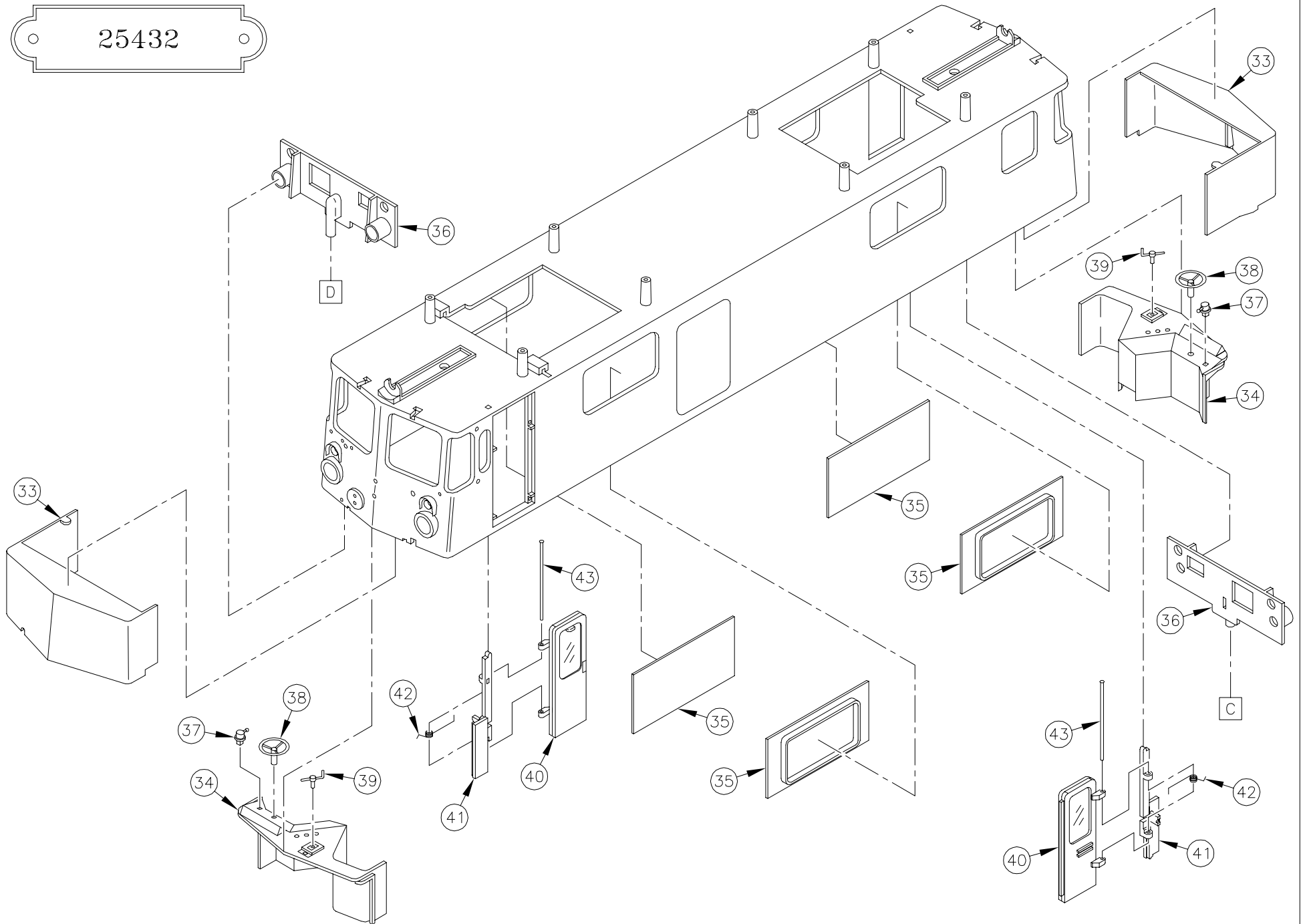

25432

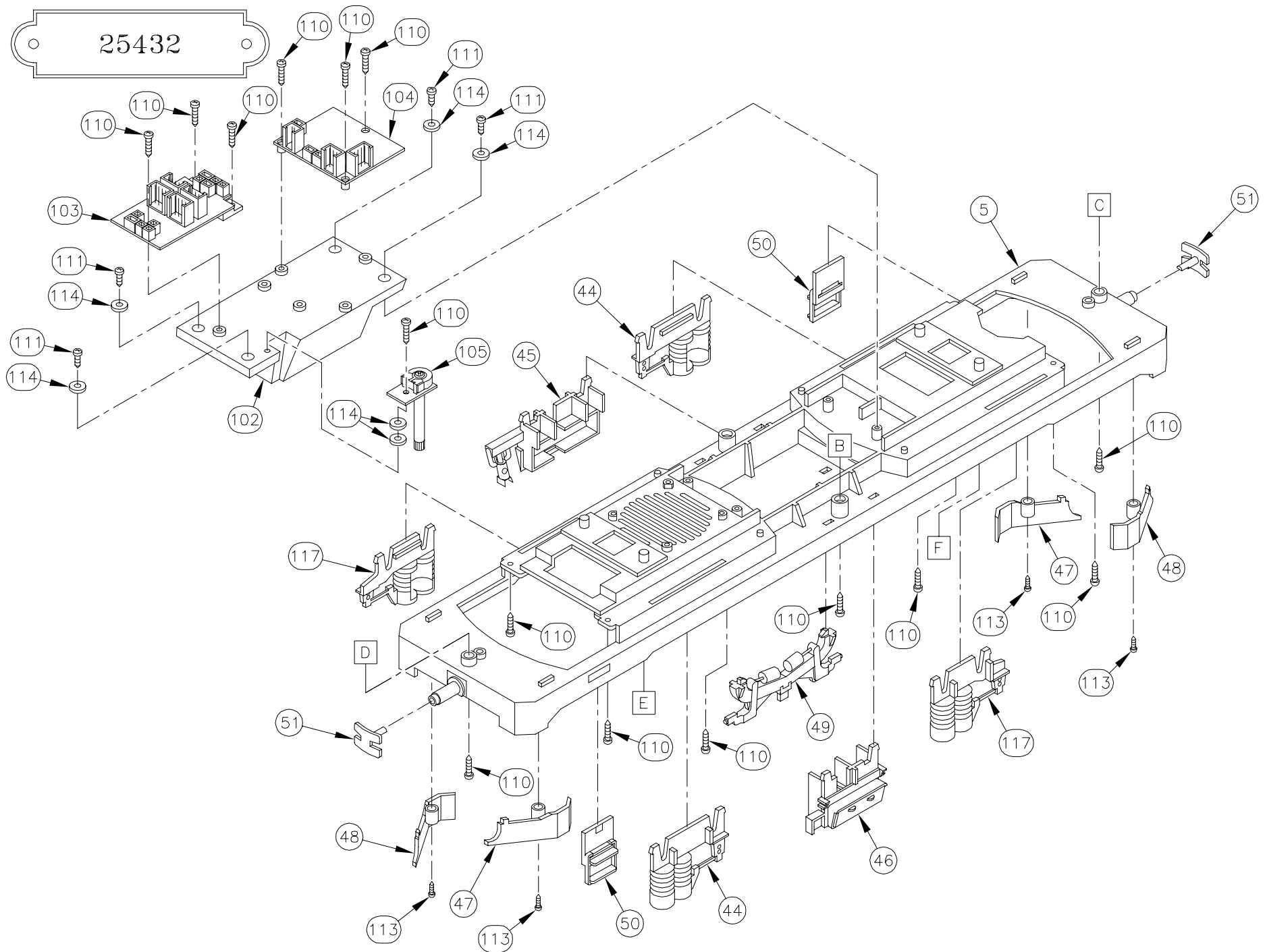

25432

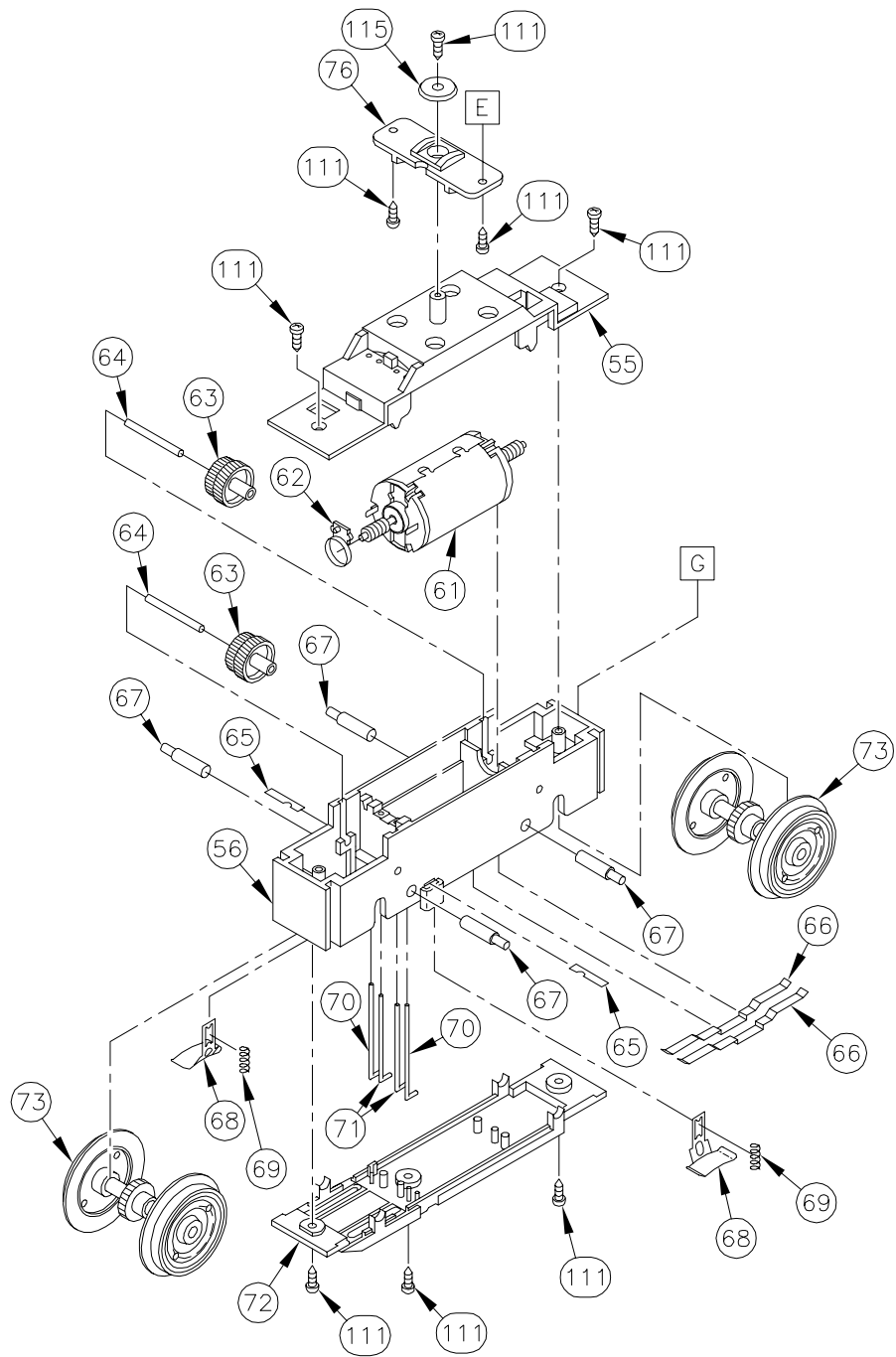
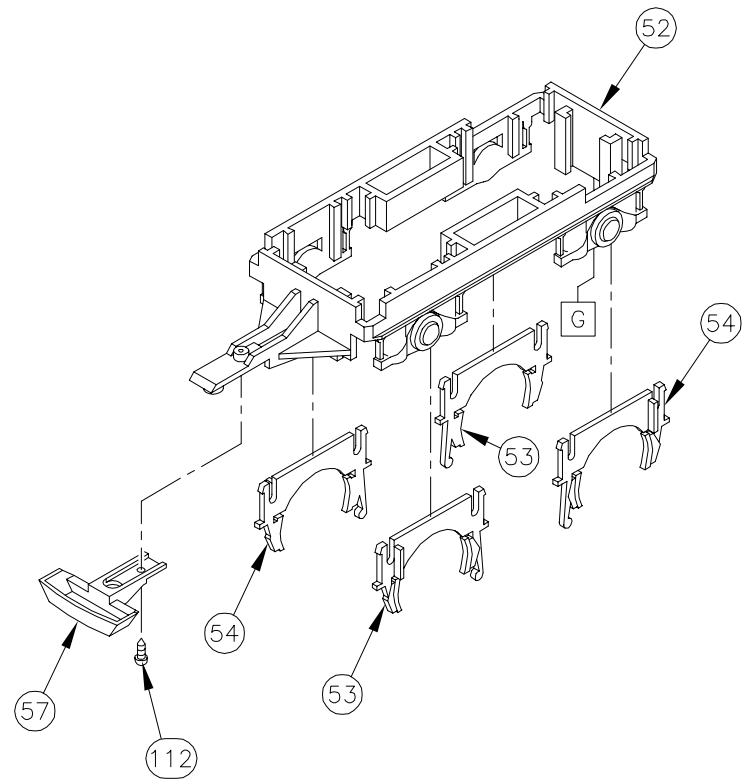

25432

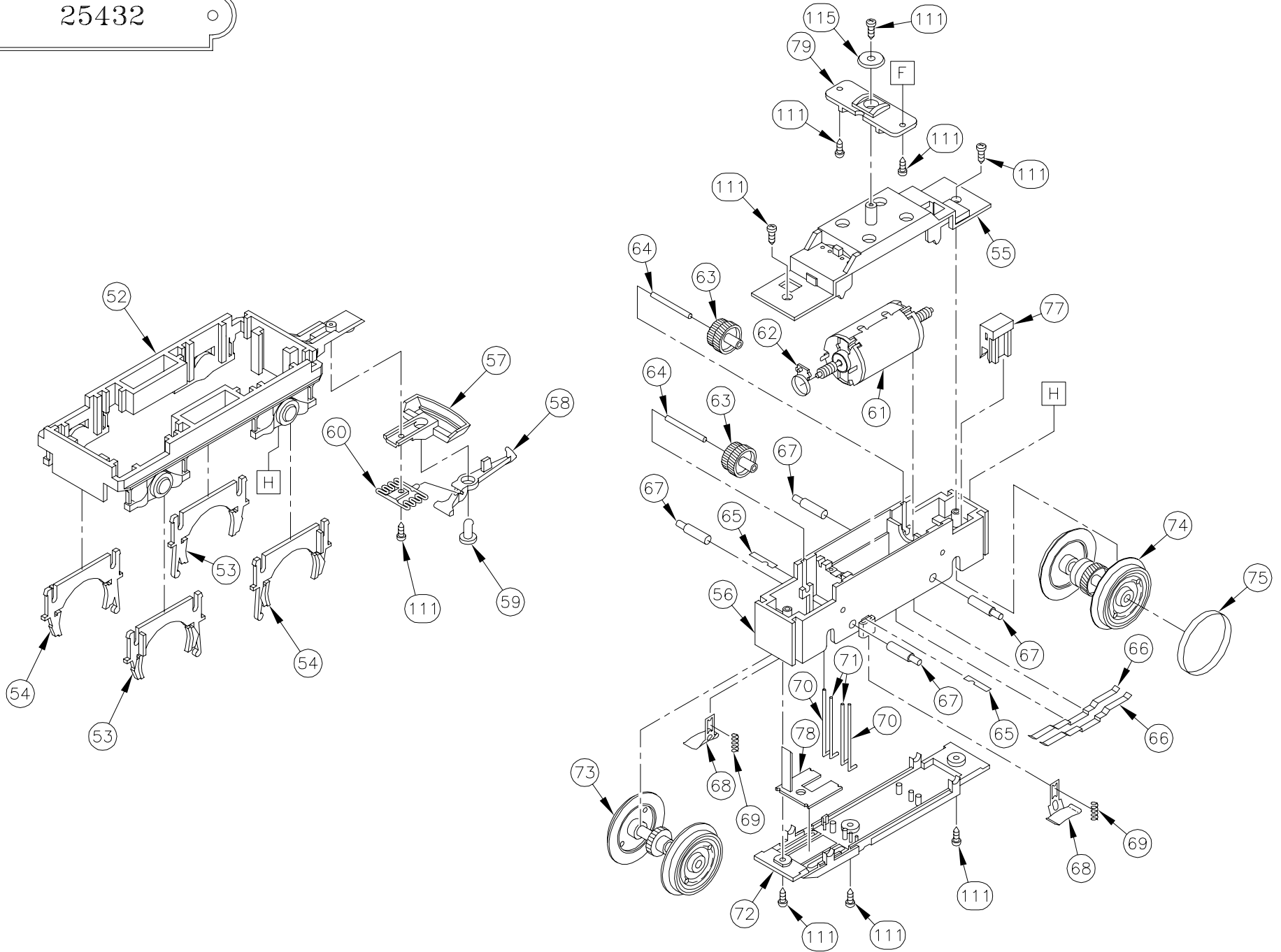

25432

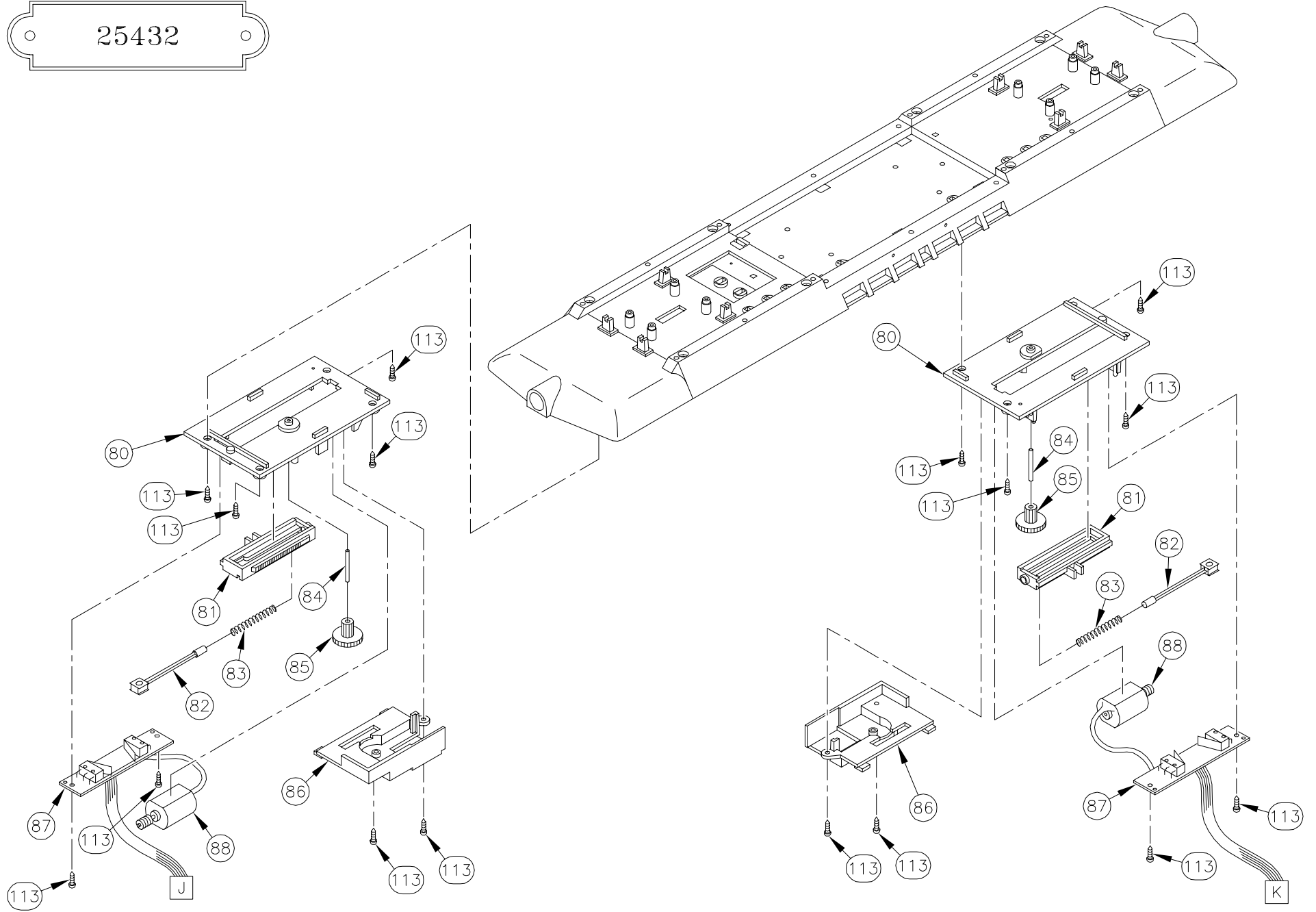



25432

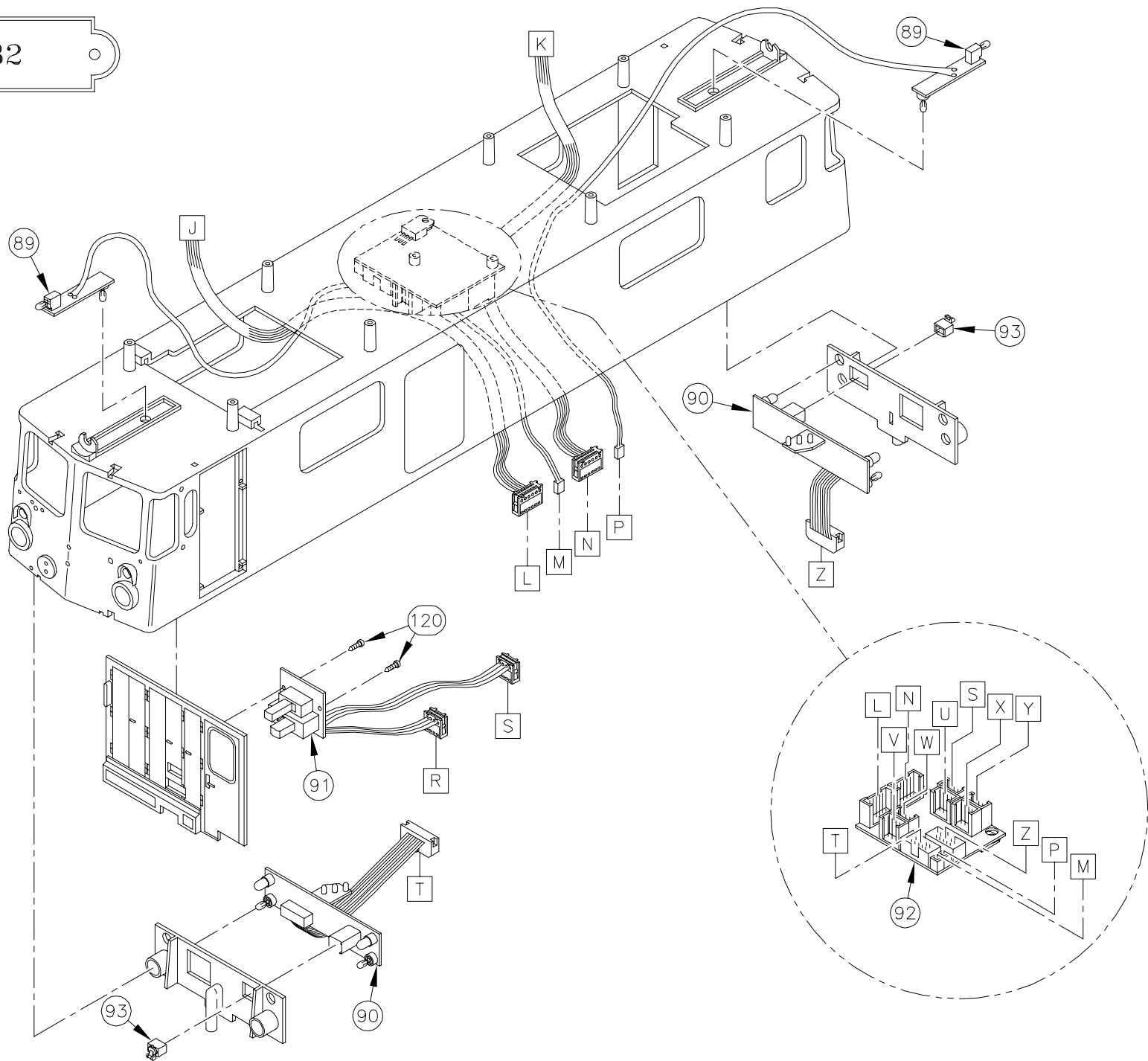

25432

